

Dispenser: 21.2900 2 THN-MS 280  
heating element 230V-1600W

Crockery:

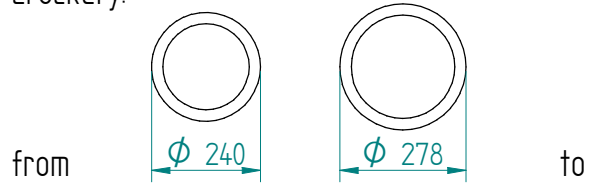

Dimensions: weight (empty): 54 kg  
A x B = trolley, excl. corner bumpers  
E x F = trolley, incl. corner bumpers  
H = trolley height  
S = effective stacking height  
T = height with push bar

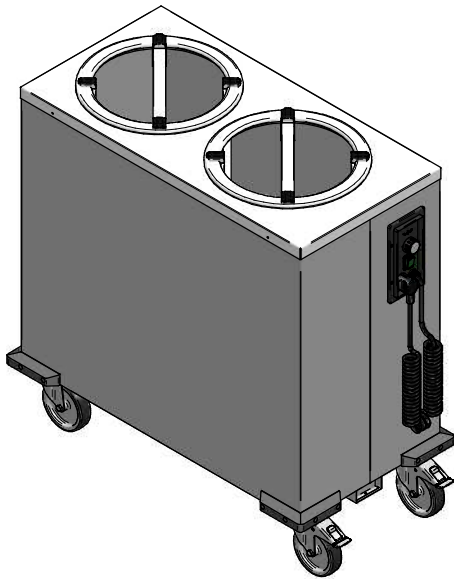

EN

VR :

IR :

**MOBILE CONTAINING**

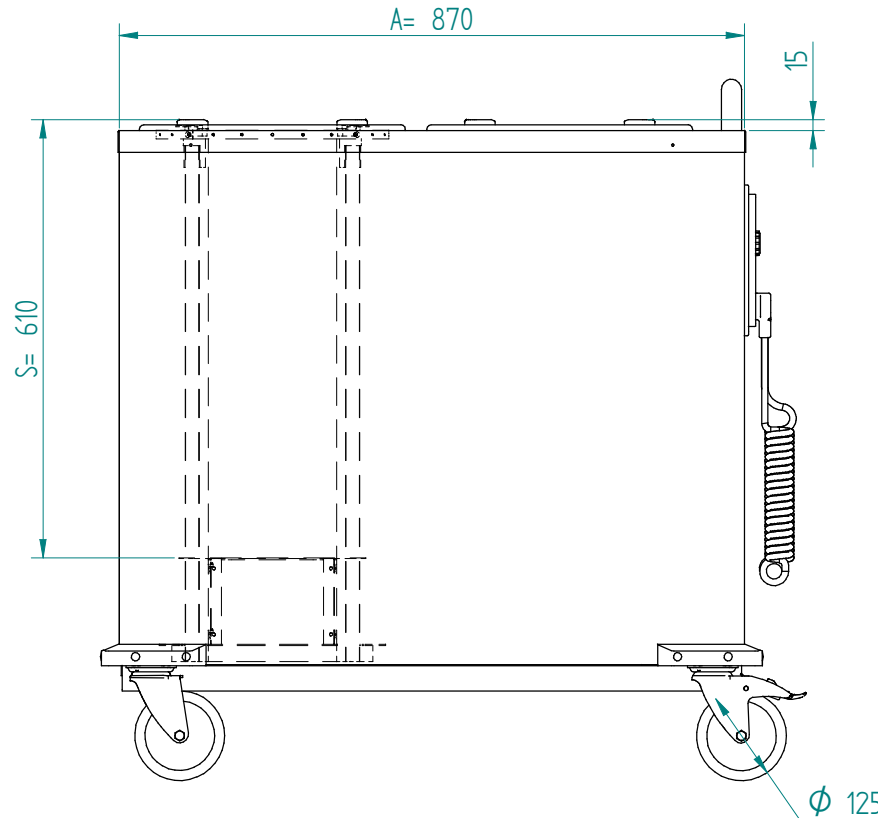
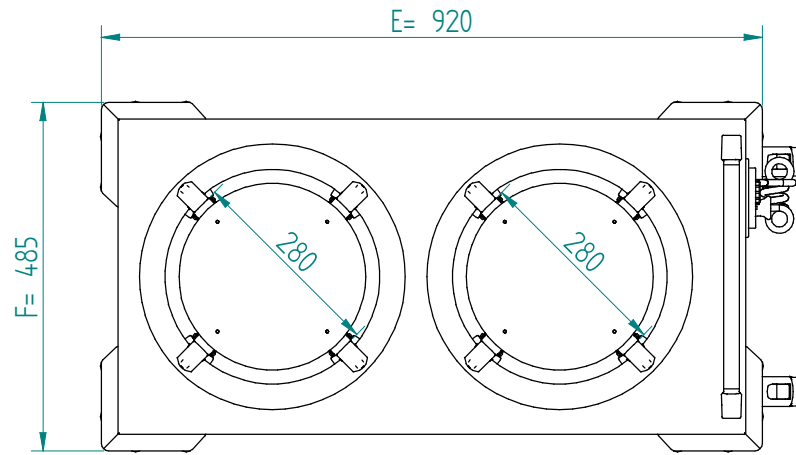

options, order separate;  
push bar: 90.5000

stst cover: 92.5085

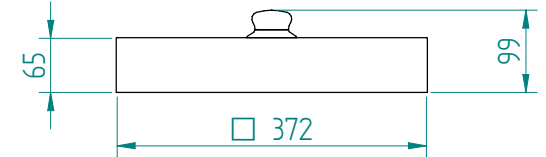

pc cover: 91.5031

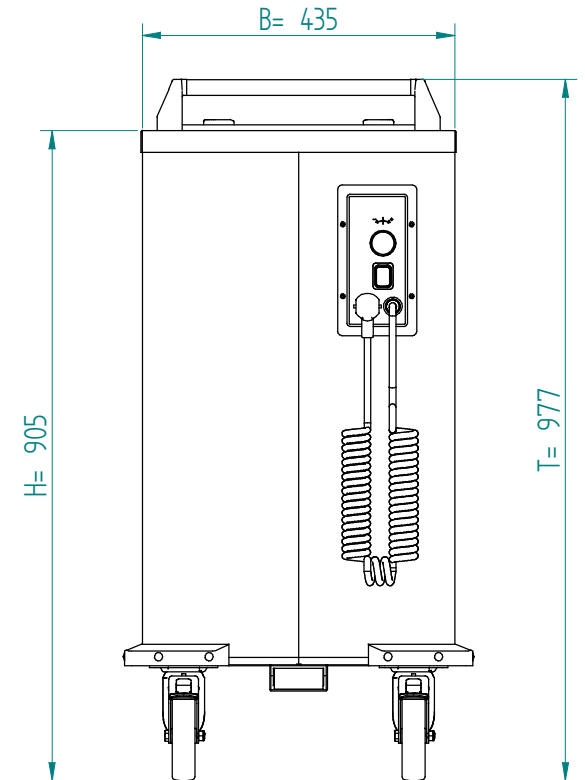
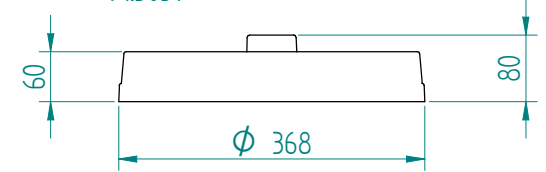

4 swivel castors, 2 with brake