

Dispenser:

45.3550

DBS 375/470

Dimensions:

A x B = trolley, excl. corner bumpers

E x F = trolley, incl. corner bumpers

l x b = tube internal

H = trolley height

S = effective stacking height

weight (empty): 19 kg

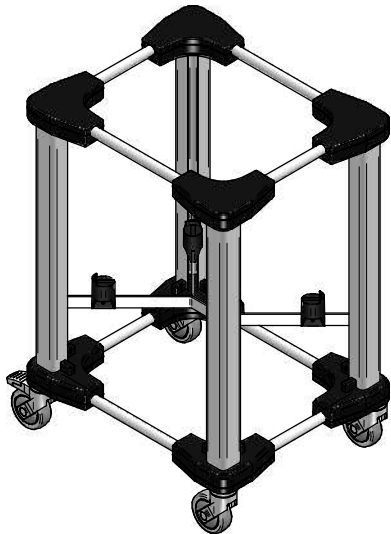

EN

VR :

IR :

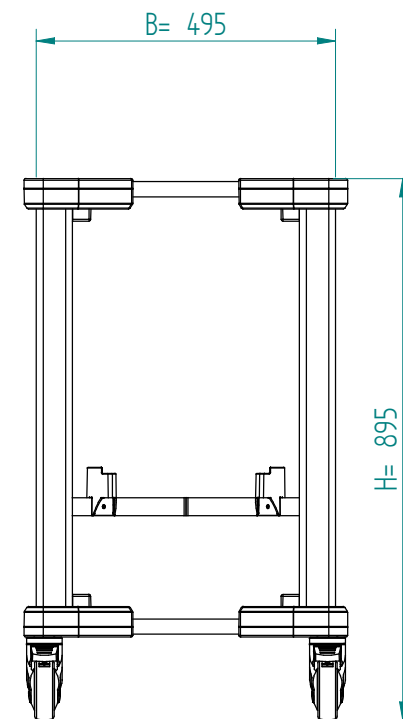
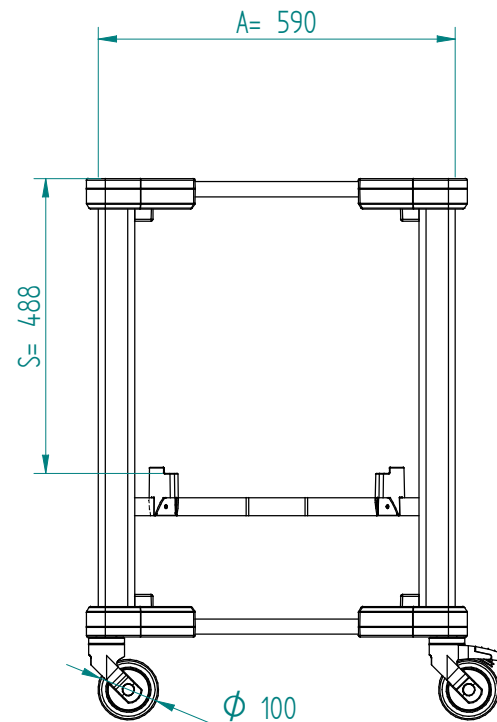
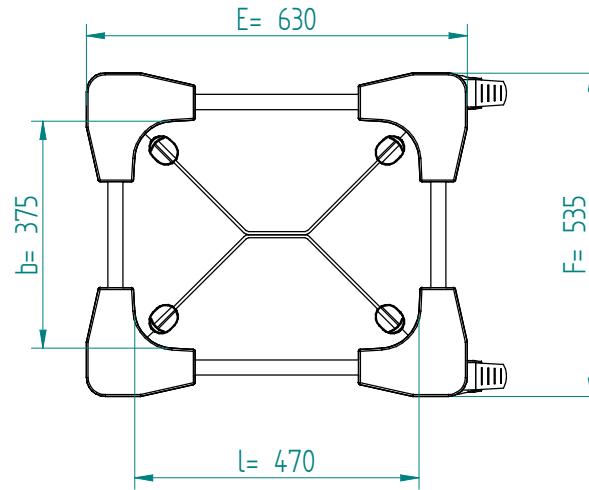

MOBILE CONTAINING

4 swivel castors, 2 with brake